

# **Crestline<sup>®</sup> Dampening System**

## **Operating Instructions**

**Hamada C248**



*A Pamarco Technologies Inc. Company*

## GENERAL INFORMATION

**ATTENTION  
CRESTLINE®  
DAMPENER  
OWNER!**

Accel Graphic Systems provides parts and service through its authorized distributors and dealers. All requests for parts and service should be directed to your local dealer.

The philosophy of Accel Graphic Systems is to continually improve all of its products. Written notices of changes and improvements are sent to Accel Graphic Systems' Dealers.

If the operating characteristics or the appearance of your product differs from those described in this manual, please contact your local Accel dealer for updated information and assistance.

Always update your dampener when improvements are made available, especially those related to safety.

**Your authorized Crestline® Dealer is:**

---

---

---

---

**The serial number of your Crestline® Dampener(s) is:**

---

---

**SAFETY  
INFORMATION**

**For your safety, do not disengage or remove any guards from the Crestline® Dampener. The dampener contains some inward rotating roller nips that can cause injury if left unguarded.**

# GENERAL INFORMATION

## CRESTLINE® CONFIGURATION

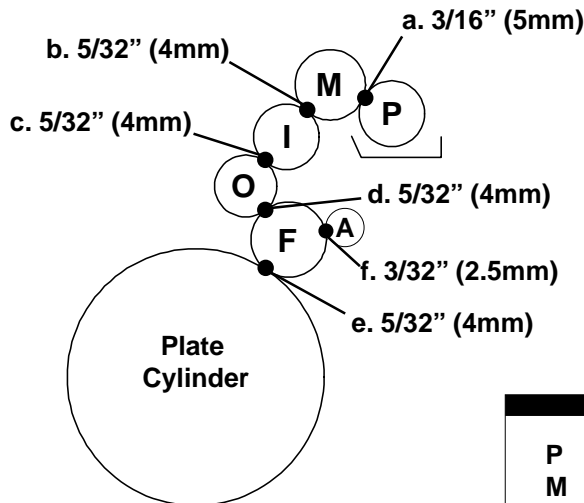

- a. Metering to Pan
- b. Metering to Intermediate
- c. Intermed. to Oscillator
- d. Oscillator to Form
- e. Form to Plate
- f. Aux. Rider to Form

- P = Pan, Hard
- M = Metering, Soft
- I = Intermediate, Soft
- O = Oscillator
- F = Form, Soft
- A = Aux. Rider, Hard

## TERMINOLOGY

OPS = Operator's Side  
 NOPS = Non Operator's Side

## TECHNICAL ASSISTANCE

For technical assistance, please contact:  
**Accel Graphic Systems**  
 11103 Indian Trail  
 Dallas, TX 75229  
 (972) 484-6808  
 FAX (800) 365-6510  
 E-Mail [accel@dallas.net](mailto:accel@dallas.net)  
 Web Site [www.accelgraphicsystems.com](http://www.accelgraphicsystems.com)

Crestline® is covered by U.S. Patents and patents pending.

Diagram #1

### IMPRESSION CYLINDER OPERATION PANEL (OP-SIDE)

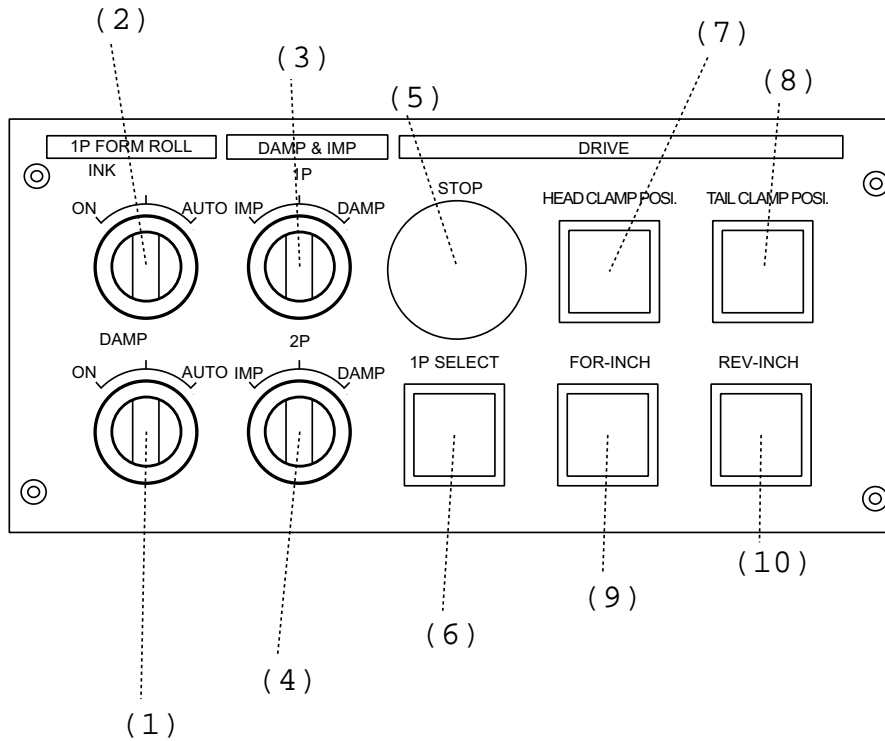

- |     |   |      |  |
|-----|---|------|--|
| (1) | 1P dampening form roller selection switch | (7)  | Plate cylinder head clamp positioning switch |
| (2) | 1P inking form roller selection switch    | (8)  | Plate cylinder tail clamp positioning switch |
| (3) | 1P impression ON / dampening ON switch    | (9)  | Inching switch (Forward)                     |
| (4) | 2P impression ON / dampening ON switch    | (10) | Inching switch (Reverse)                     |
| (5) | Main drive stop switch                    |      |  |
| (6) | 1P selection switch                       |      |  |

## BASIC OPERATION

### 1

#### OPERATION PANEL CONTROLS

The control panel operation changes very little with installation of Crestline® dampener. Refer to the opposite diagram for the function of all knobs and switches related to dampener operation. Generally speaking, the knobs should be in the "AUTO" mode for normal printing operation. In this position, all rollers will sequence automatically as printing commences. Refer to your press operation manual for any questions related to the functions of other knobs and switches on the panels.

**NOTE: The toggle switches on the delivery section operation panel (#11 & #12 in diagram 2, page 6) should be turned to the OFF position and left there. These switches have no function once Crestline® is installed.**

### 2

#### IMPRESSION CYLINDER OPERATION PANEL DIAGRAM #1

##### (1) 1P DAMPENING FORM ROLLER SELECTION SWITCH

<b>ON</b>	Dampener form roller will drop to the plate when the press is rotated even if paper is not being fed.
<b>MIDDLE (OFF)</b>	Dampener form roller will not drop to the plate.
<b>AUTO</b>	Dampener form roller will drop to the plate only when printing operation commences. This position is for normal operation.

Diagram #2

### DELIVERY SECTION OPERATION PANEL (OP-SIDE)

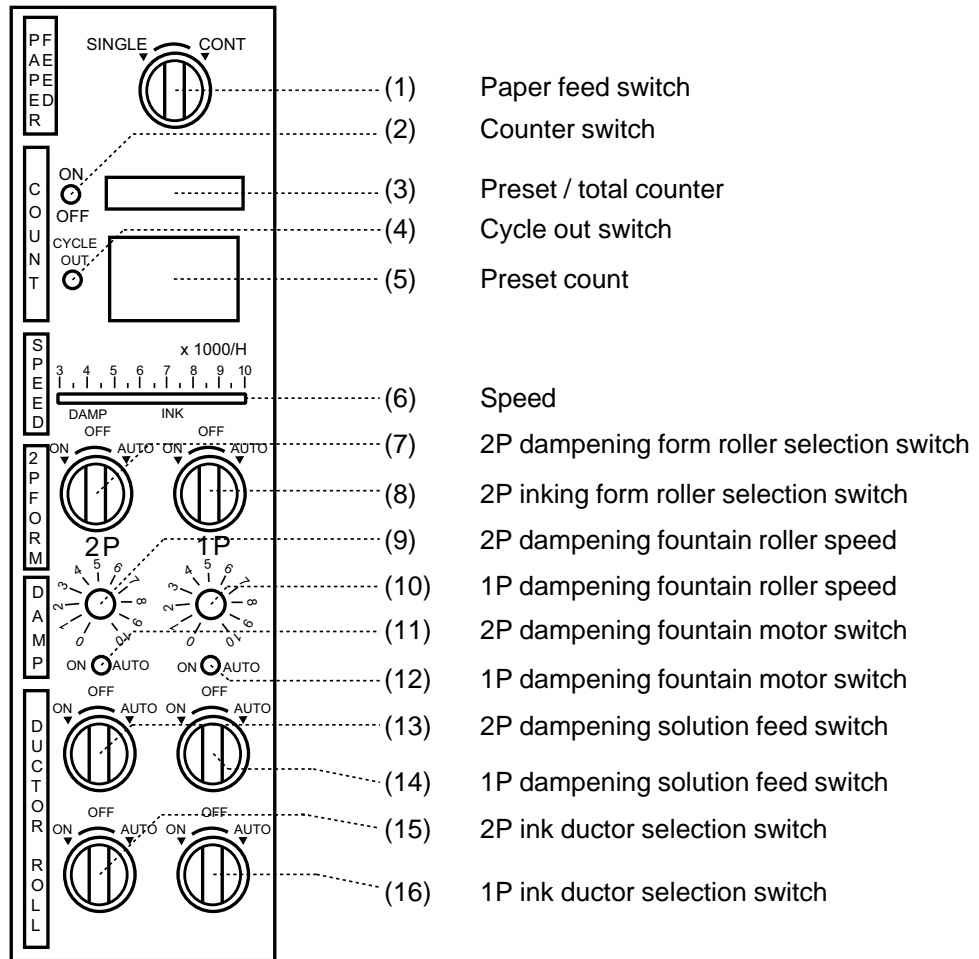

## BASIC OPERATION

### 3

#### DELIVERY SECTION OPERATION PANEL DIAGRAM #2

##### (7) 2P DAMPENING FORM ROLLER SELECTION SWITCH

- |                     |  |
|---------------------|--|
| <b>ON</b>           | Dampener form roller will drop to the plate when the press is rotated even if paper is not being fed.                      |
| <b>MIDDLE (OFF)</b> | Dampener form roller will not drop to the plate.   |
| <b>AUTO</b>         | Dampener form roller will drop to the plate only when printing operation commences. This position is for normal operation. |

##### (9) THROUGH (12)

These controls have no purpose when Crestline® is installed.

##### (13) 2P DAMPENING SOLUTION FEED SWITCH.

- |                     |   |
|---------------------|---|
| <b>ON</b>           | Dampener intermediate roller will drop down to contact dampener oscillator when the press is rotated even if paper is not being fed.                      |
| <b>MIDDLE (OFF)</b> | Dampener intermediate roller will not drop down to contact dampener oscillator.   |
| <b>AUTO</b>         | Dampener intermediate roller will drop down to contact dampener oscillator only when printing operation commences. This position is for normal operation. |

##### (14) 1P DAMPENING SOLUTION FEED SWITCH

See #13 above for explanation.

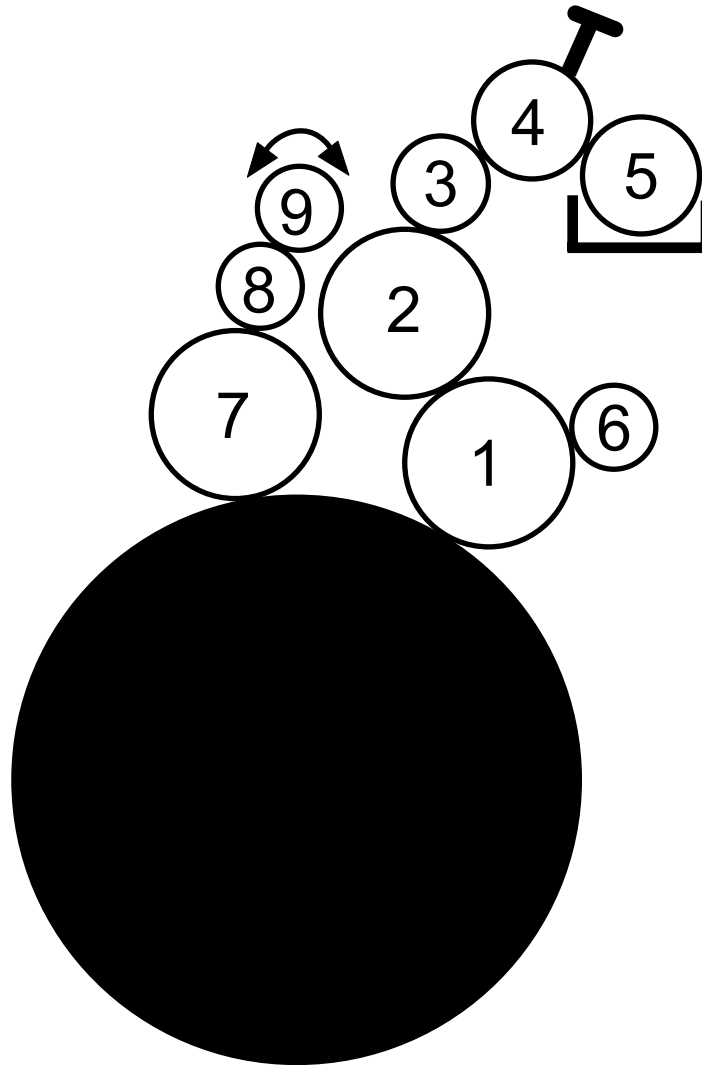

- 1 Crestline® Water Form Roller
- 2 Water Oscillator Roller
- 3 Crestline® Intermediate Roller
- 4 Crestline® Metering Roller
- 5 Crestline® Pan Roller
- 6 Crestline® Auxiliary Rider Roller
- 7 Ink Form Roller
- 8 Lower Bridge Roller
- 9 Upper Bridge Roller

## BASIC OPERATION

### 4

#### PREPARING THE DAMPENER FOR PRINTING

- A. Make sure the dampener metering roller (#4) is in place and the knurled knobs are turned all the way down.
- B. Engage the bridge rollers (#8 & #9) which connect the ink rollers (#7, et.al) to the dampener oscillator (#2).
- C. On the delivery section control panel, turn the dampening solution feed switches (#13 and #14 on diagram #2, page 6) to the ON position. This will allow the dampener intermediate (#3) and oscillating (#2) rollers to engage while the press idles.
- D. Turn on the press and allow the ink and dampener rollers to ink up. After a very light film of ink is allowed to build on the dampener, turn the solution feed switches to the AUTO position. When the inker is sufficiently inked up, turn off the press and disengage the bridge roller from the dampener oscillator.
- E. Make sure the water pan and all hoses are properly attached and the brass weir is in place over the drain hole. Turn on the circulator and adjust the flow. A very slow flow is all that is required for proper circulation.
- F. Turn all ink and water controls to the AUTO position. Position other knobs as needed for the job. The dampener is now ready to print.

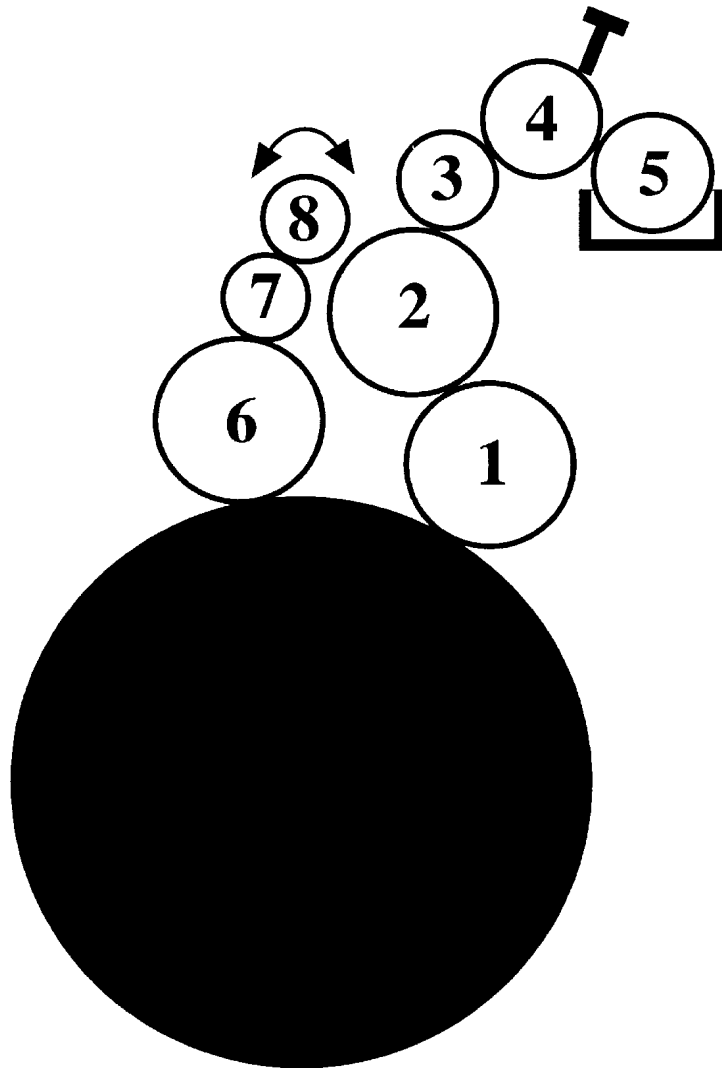

- 1 Crestline® Water Form Roller
- 2 Water Oscillator Roller
- 3 Crestline® Intermediate Roller
- 4 Crestline® Metering Roller
- 5 Crestline® Pan Roller
- 6 Crestline® Auxiliary Rider Roller
- 7 Ink Form Roller
- 8 Lower Bridge Roller
- 9 Upper Bridge Roller

## BASIC OPERATION

### 5

#### ADJUSTING THE AMOUNT OF WATER DELIVERED TO THE PLATE

The volume of water delivered to the printing plate is adjusted by the knurled knobs on top of the dampener. Generally speaking, you should begin all jobs with the knobs turned all the way down. This is the minimum water position for Crestline®. Should you require more water on the plate, turn the knobs counterclockwise one "click" at a time until desired water volume is achieved.

Typically, the Crestline® does not have to be adjusted from job to job which have different ink coverages. The automatic moisture control features of the dampener will compensate for this. However, more water is usually required when switching from a metal or electrostatic plate to a silver-based paper plate.

Accel recommends using a fountain solution formulated for the specific type of plate being used.

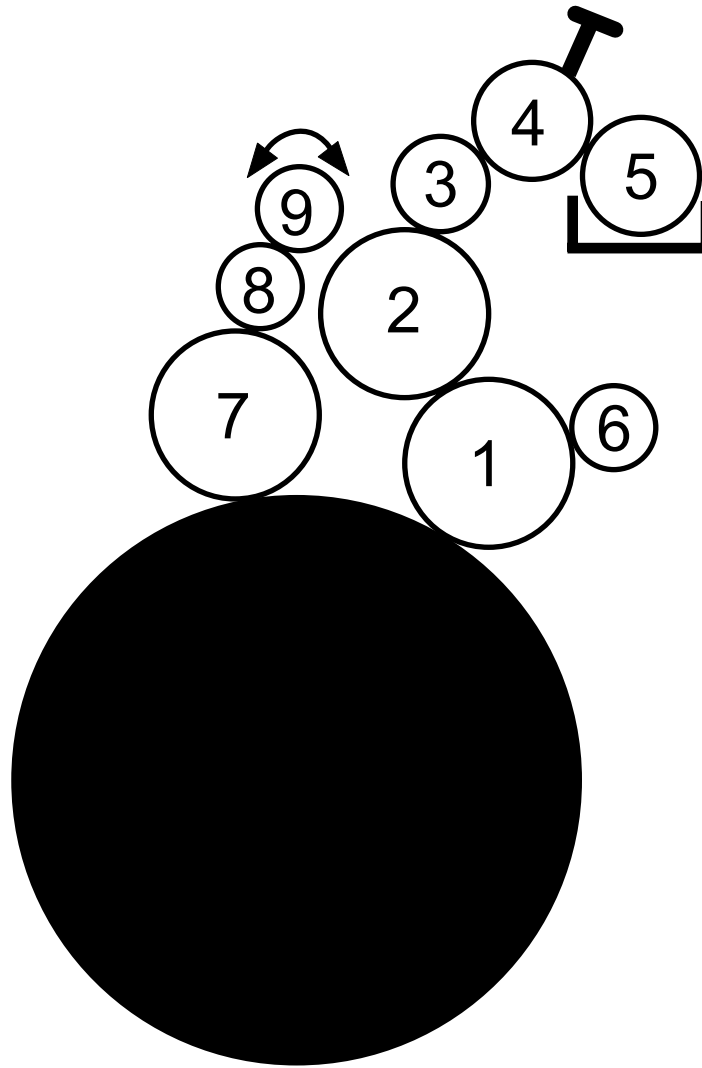

- 1 Crestline® Water Form Roller
- 2 Water Oscillator Roller
- 3 Crestline® Intermediate Roller
- 4 Crestline® Metering Roller
- 5 Crestline® Pan Roller
- 6 Crestline® Auxiliary Rider Roller
- 7 Ink Form Roller
- 8 Lower Bridge Roller
- 9 Upper Bridge Roller

## CLEANING & MAINTENANCE

### 1

#### WASHING UP THE CRESTLINE® DAMPENER

Generally speaking, the Crestline® must be washed up upon each color change and at the end of the day. The following procedures should be followed:

- A. Turn off circulator, remove brass weir from water pan, and allow pans to drain. If necessary, loosen water pan knob at NOPS and drop pan down to aid draining.
- B. Engage bridge roller that connects ink rollers to the dampening rollers.
- C. Turn dampening solution feed switches (#13 and #14 on diagram #2, page 6) to the ON position.
- D. Turn on press and apply roller wash to ink rollers only. The bridge roller will take the roller wash to the dampener. Avoid applying roller wash directly to the dampener rollers as most of it will end up in the water pan if you do. Continue washing up in this manner until the inker and dampener are clean. Excess wash may accumulate on the ends of the Crestline® pan and metering rollers so make sure to wipe down these rollers by hand after you turn off the press.
- E. Remove water pan and inspect for any excess wash that may have dripped from the dampener rollers. If needed, wipe the pan clean and then re-mount.
- F. If this is the last wash-up of the day, spin the knurled knobs counterclockwise 2 full turns to relieve the pressure on the metering roller. Be sure to spin these knobs back down before beginning the next day.

**CRESTLINE®  
CLEANING & MAINTENANCE CHART**

	Daily	Weekly	Bi-Weekly	Monthly
Wash Rollers	✓			
Deglaze Rollers				
Metal Plate Users			✓	
Silvermaster Plate Users			✓	
Electrostatic Plate Users		✓		
Inspect Ball Bearings				✓
Check Roller Pressures				✓
Check Roller Surfaces				✓

## CLEANING & MAINTENANCE

2

### DEGLAZING THE CRESTLINE®

Periodic deglazing of water-soluble contaminants will be necessary with the Crestline®. Typically, once every 2-3 weeks will be sufficient, unless you are running electrostatic plates on a daily basis whereas deglazing should be performed weekly. A 50/50 solution of household ammonia and hot water can be used for deglazing purposes. If you prefer a commercially available deglazer, avoid those containing pumice or gritty substances. Always follow deglazing with straight water and then roller wash. Accel offers a product called **COMPOUND X** that we recommend for deglazing our system. Contact your dealer or Accel for more information.

3

### OILING AND GREASING CRESTLINE®

Place a small amount of grease on the gears once a month. The remainder of the dampener either contains maintenance-free ball bearings or will be oiled by the central lubrication system on the press.

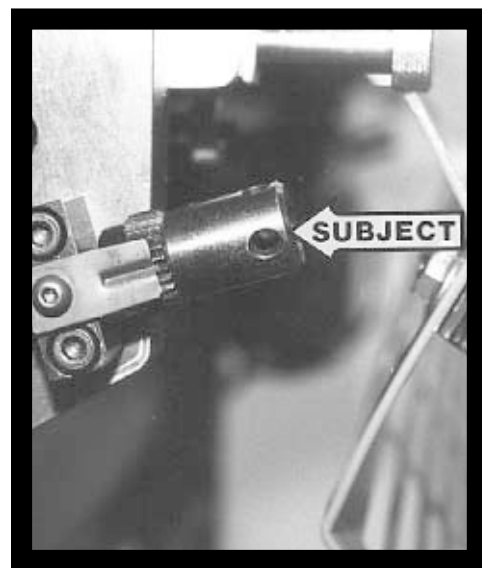
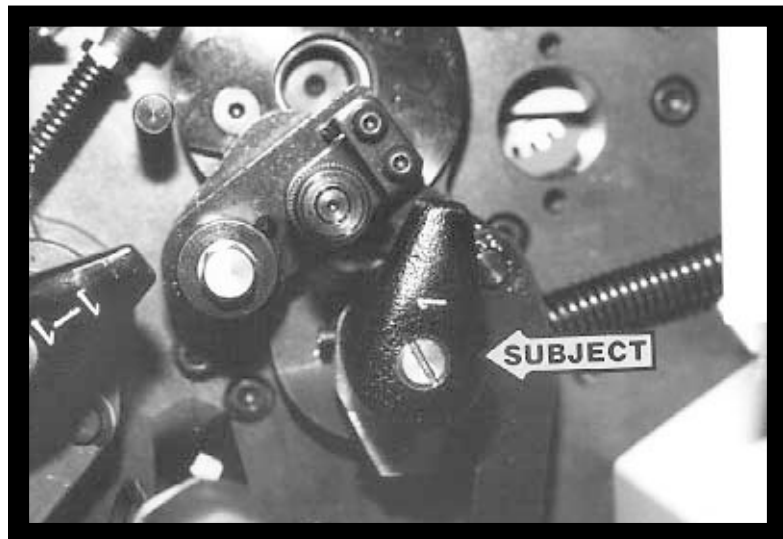

# DAMPENER ADJUSTMENTS

## 1

### INKING UP THE DAMPENER

Make sure Crestline® metering roller is in place and turn thumb screws on top of dampener down until you can feel some pressure being applied to the metering roller. Turn the dampener form roller switches for both printing units to the OFF position. Turn dampening switches (#13 & #14 on diagram #2, page 6) to the ON position. Engage bridge roller to the dampening oscillating roller. Apply ink to the ink rollers or place ink in the fountain. Turn on press and run slowly to distribute ink to the inker and dampener (dampener will pick up ink from the bridge roller). While the press is running, check to see that the Crestline® is running smoothly with no apparent noises. Stop the press a couple of times during the initial run to apply grease to the dampener gears. Once the press is sufficiently inked-up, stop the press.

## 2

### WATER FORM TO WATER OSCILLATOR PRESSURE

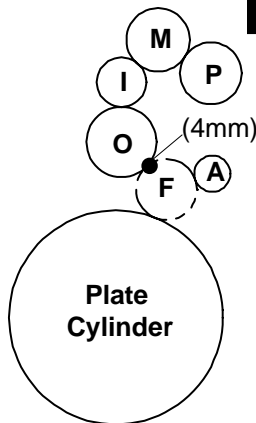

The first Crestline® adjustment to check is the oscillator to form pressure. After the press sits still for about 30 seconds, you should be able to jog the press forward and see a stripe (bead line) on the form or oscillating roller. This stripe should be 4 mm (5/32"). To adjust, locate the outer set screw on the side of the water form shaft (subject arrow). Loosen this set screw and, with a standard screw driver, turn the slotted screw on the end of the form roller shaft. Turning the slotted screw clockwise will increase this stripe, counterclockwise will decrease it.

## 3

### WATER FROM TO PRINTING PLATE PRESSURE

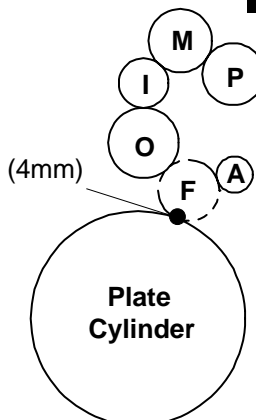

The second stripe to check is water form to plate. With a metal plate mounted to the cylinder, take T-wrench supplied with press, place over hex stud underneath registration adjustment knob (subject arrow, left picture). Turn clockwise to the #1 position and then back to zero. Jog the press backwards and observe the stripe left on the plate. This stripe should be 4 mm (5/32"). It is adjusted identical to the original dampener form by turning the indexed knobs at each side of printing head (subject arrow, right picture). Turning the knobs down decreases the stripe and vice-versa.

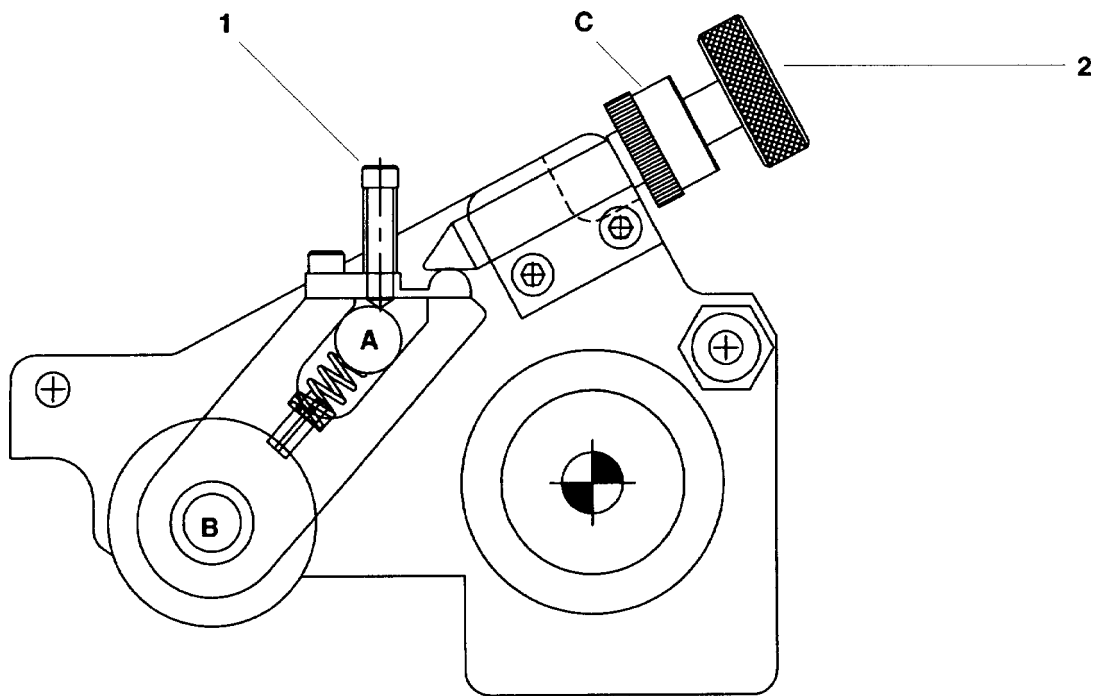
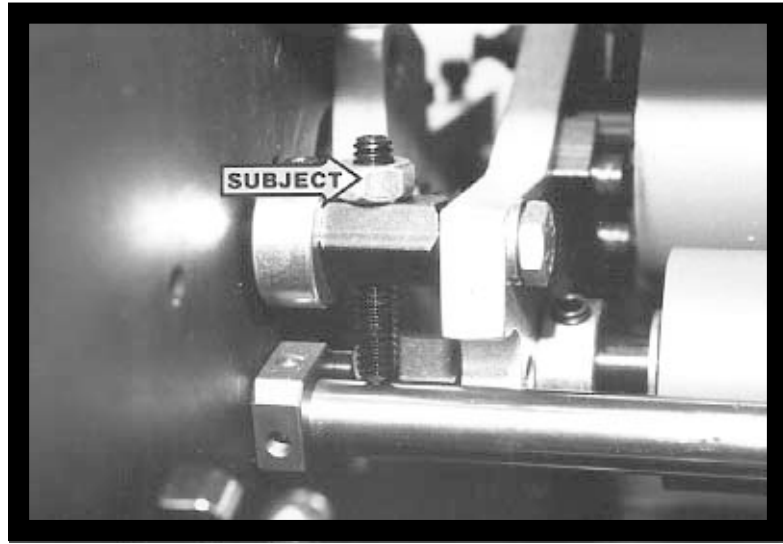

# DAMPENER ADJUSTMENTS

## 4

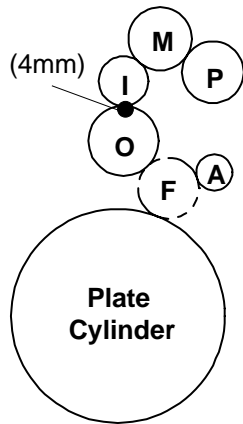

### DAMPENER INTERMEDIATE TO OSCILLATOR PRESSURE

The next stripe to check is the dampener intermediate roller to dampener oscillating roller. The dampener intermediate roller is the forward-most roller in the upper dampener assembly and sits on top of oscillator. The stripe can be seen by jogging the press forward and observing the bead line left on the intermediate roller. This stripe should also be 4 mm (5/32"). To adjust, loosen lock nut on roller adjustment mechanism (subject arrow) and turn screw down to decrease the stripe, or up to increase. Re-tighten lock nut when finished. (Remember that the dampening knobs, #13 & #14 on diagram #2, page 6, must be in the ON position for these two rollers to be in contact.)

## 5

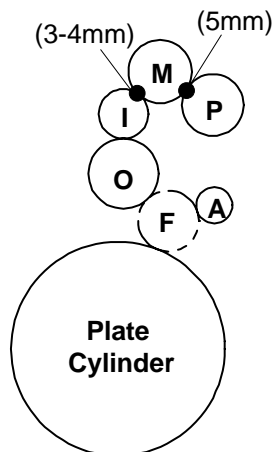

### DAMPENER METERING TO INTERMEDIATE & PAN ROLLER PRESSURE

- A. Turn screw (1) clockwise. This **increases** the pressure on the metering roller shaft (A) and creates more pressure between the metering & intermediate rollers. Check the pressure by rotating the press *backwards* with the water form engaged to the plate. The stripe should be 3mm - 4mm (1/8" - 5/32").
- B. Turn knob (2) clockwise. This **increases** the pressure on the hanger bracket and creates more pressure between the metering and pan rollers. Check the pressure by rotating the press *forwards*. The pressure should be 5mm (3/16"). Lock the pressure in place by turning the ratchet gear (C) clockwise until it stops. Tighten set screws in the ratchet gear to retain pressure setting.

## 6

### CIRCULATOR FLOW

The last setting to make is the circulator flow into the water pan. Fill the circulator with fountain solution. Initially, completely shut off the filler valves, turn circulator on, and slowly open until you can see fountain solution flowing into the pan. Generally speaking, you do not need much more than a trickle to maintain good circulation. Too much flow can mean the pan will fill faster than it can drain, and therefore overflow.



## DAMPENER ADJUSTMENTS

**7**

You are now ready to print. Return all knobs to the automatic position. Generally speaking, the knobs should be left in this position for normal printing operation. In the automatic mode, the dampener form roller will be off the plate, and the intermediate roller will be off the oscillator when the press is idling. When printing commences, these rollers will drop in the required sequence and the plate will receive water.

The toggle switch that controlled the original dampener motor can be switched to the off position and left there, as this switch no longer has a function.

If you have any questions regarding the function of the control panel knobs and switches, please refer to your Hamada manual.







*A Pamarco Technologies Inc. Company*

11103 Indian Trail, Dallas, TX 75229 Phone 972-484-6808, Fax 800-365-6510  
E-Mail [info@accel-us.com](mailto:info@accel-us.com), Web Site [www.accel-us.com](http://www.accel-us.com)